

# SITRANS P measuring instruments for pressure

## Transmitters for gauge, absolute and differential pressure

### Z series for gauge pressure

#### Overview



SITRANS P pressure transmitters, Z series for gauge pressure (7MF1562-...)

The SITRANS P pressure transmitter, Z series (7MF1562-...), measures the gauge pressure of aggressive and non-aggressive gases, liquids and vapors.

#### Benefits

- High measuring accuracy
- Sturdy brass housing
- For aggressive and non-aggressive media
- For measuring the gauge pressure of liquids, gases and vapor
- Temperature-compensated measuring cell
- Compact design

#### Application

The pressure transmitter of the Z series for gauge pressure (7MF1562-...) is used above all in the following industrial areas:

- Power engineering
- Mechanical engineering
- Shipbuilding
- Water supply etc.

A concrete application example is the measurement of compressed air containing oil in compressors or compressor stations.

#### Design

The main components of the pressure transmitter are:

- Brass housing with silicon measuring cell and electronics plate
- Process connection
- Electrical connection

The silicon measuring cell has a thin-film strain gauge which is mounted on a ceramic diaphragm. The ceramic diaphragm can also be used for aggressive media.

The process connection to DIN EN 837-1 is made of brass and has a male thread  $G\frac{1}{2}B$  or a female thread  $G\frac{1}{8}B$ .

The electrical connection is made using a plug to DIN 43650 with a M16x1.5 cable inlet.

#### Function

The pressure transmitters of the Z series for gauge pressure measure the gauge pressure of aggressive and non-aggressive gases, liquids and vapors.

The measuring cell is temperature-compensated.

#### Mode of operation

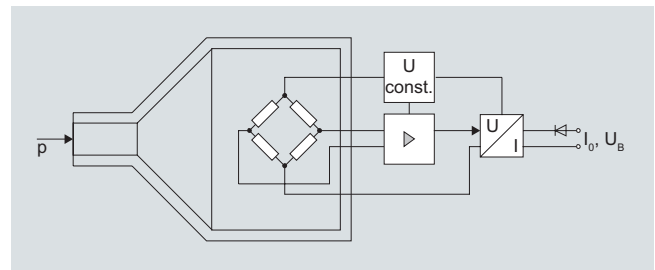

SITRANS P pressure transmitters, Z series (7MF1562-...), functional diagram

The thin-film measuring cell has a thin-film resistance bridge at which the operating pressure  $p$  is transmitted through a ceramic diaphragm.

The measuring cell output voltage is fed to an amplifier and converted into an output current of 4 to 20mA. The output current is linearly proportional to the input pressure.

# SITRANS P measuring instruments for pressure

## Transmitters for gauge, absolute and differential pressure

### Z series for gauge pressure

#### Technical specifications

##### SITRANS P pressure transmitter, Z series for gauge pressure

#### Mode of operation

Measuring principle Thin-film strain gauge

#### Input

Measured variable Realtime pressure  
 Measured range 0 to 16 bar g (0 to 232 psi g) or  
 0 to 25 bar g (0 to 363 psi g)

#### Output

Current output signal 4 ... 20 mA

#### Measuring accuracy

To EN 60770-1  
 Error in measurement (at 25 °C (77 °F), including conformity error, hysteresis and repeatability) 0.5% of full-scale value-typical  
 Response time  $T_{99}$  < 0.1 s  
 Long-term drift 0.3% of full-scale value/year - typical  
 Influence of ambient temperature  
 • Start of scale 0.3%/10 K (0.3%/10 K) of full-scale value - typical  
 • Measured span 0.3%/10 K (0.3%/10 K) of full-scale value - typical

#### Rated conditions

Medium conditions  
 • Process temperature -30 ... +120 °C (-22 ... +248 °F)  
 Degree of protection to EN 60529 IP65  
 Ambient conditions  
 • Ambient temperature -25 ... 85 °C (-13 ... +185 °F)  
 • Storage temperature -50 ... 100 °C (-58 ... +212 °F)

#### Design

Weight ≈ 0.2 kg (≈ 0.44 lb)  
 Wetted parts materials  
 • Measuring cell  $Al_2O_3$  - 96%  
 • Process connection Brass, mat. No. 2.0402  
 • Gasket Viton  
 Process connection Male thread  $G\frac{1}{2}B$   
 female thread  $G\frac{1}{8}B$

#### Power supply

Terminal voltage on pressure transmitter

• For current output 10 ... 36 V DC

#### Certificate and approvals

Classification according to pressure equipment directive (DRGL 97/23/EC) For gases of fluid group 1 and liquids of fluid 1; complies with requirements of article 3, paragraph 3 (sound engineering practice)

#### Dimensional drawings

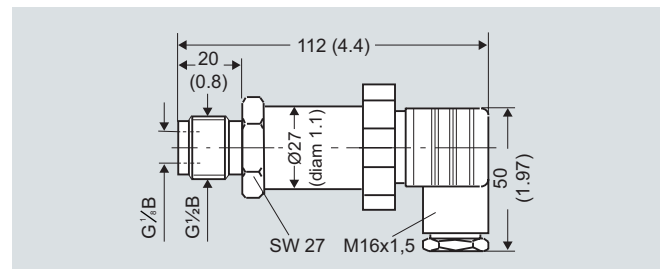

SITRANS P pressure transmitters, Z series (7MF1562-...), dimensions in mm (inch)

#### Schematics

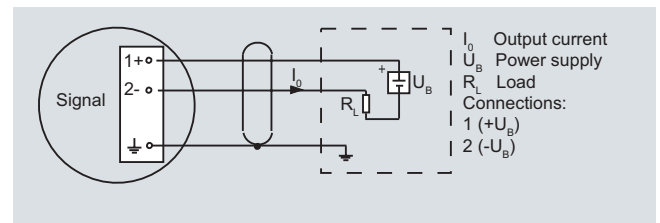

SITRANS P pressure transmitters, Z series (7MF1562-...), connection diagram

#### Selection and Ordering data

SITRANS P pressure transmitters, Z series for pressure  
 2-wire system, characteristic rising

Order No.

Order code

D) 7MF1562 - ■ ■ ■ 0 0

#### Measured range

0 ... 16 bar g (0 ... 232 psi g)  
 0 ... 25 bar g (0 ... 363 psi g)

#### Max. working pressure

32 bar g (464 psi g)  
 64 bar g (928 psi g)

Other version for measuring range  $\geq 1$  bar g ( $\geq 14.5$  psi g), add Order code and plain text:  
 Measuring range: ... to ... bar g (psi g)

3 CB  
 3 CD

9 AA

H 1 Y

D) Subject to export regulations AL: N, ECCN: EAR99H.

# SITRANS P measuring instruments for pressure

## Transmitters for gauge, absolute and differential pressure

### Z series for gauge and absolute pressure

#### Overview



SITRANS P pressure transmitters, Z series for pressure and absolute pressure (7MF1564-...)

SITRANS P pressure transmitters, Z series (7MF1564-...), measure the gauge and absolute pressure as well as the level of liquids and gases.

#### Benefits

- High measuring accuracy
- Sturdy stainless steel housing
- For aggressive and non-aggressive media
- For measuring the pressure of liquids, gases and vapor
- Temperature-compensated measuring cell
- Compact design

#### Application

The pressure transmitter of the Z series for gauge pressure and absolute pressure (7MF1564-...) is used above all in the following industrial areas:

- Chemical industry
- Pharmaceutical industry
- Food industry
- Mechanical engineering
- Shipbuilding
- Water supply

#### Design

The design of the pressure transmitter is dependent on the measuring range.

##### Measuring range <1 bar (<14.5 psi)

Main components:

- Stainless steel housing with piezo-resistive silicon measuring cell (with stainless steel diaphragm, temperature-compensated) and electronics module
- Process connection made of stainless steel in diverse designs (see Selection and Ordering data)
- Electrical connection made using a plug to DIN 43650 with the cable inlet M16 x 1.5, 1/2-14 NPT or round plug connector M12.

The pressure transmitters with a nominal range < 1 bar g (< 14.5 psi g) are optionally available with or without explosion protection.

##### Measuring range ≥1 bar (≥14.5 psi)

Main components:

- Stainless steel housing with ceramic measuring cell and electronics module. The temperature-compensated ceramic measuring cell has a thin-film strain gauge which is mounted on a ceramic diaphragm. The ceramic diaphragm can also be used for aggressive media.
- Process connection made of stainless steel in diverse designs (see Selection and Ordering data)
- Electrical connection made using a plug to DIN 43650 with the cable inlet M16 x 1.5, 1/2-14 NPT or round plug connector M12.

The pressure transmitters with a nominal range ≥ 1 bar g (≥ 14.5 psi g) are optionally available with or without explosion protection.

#### Function

The pressure transmitter measures the gauge and absolute pressure as well as the level of liquids and gases.

##### *Mode of operation*

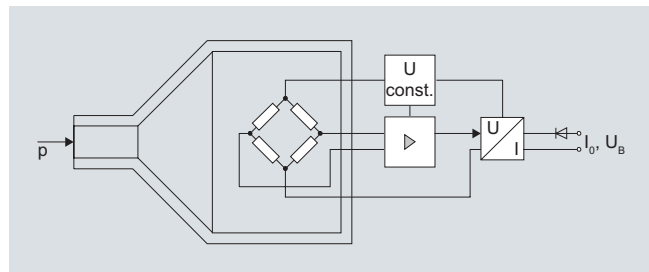

SITRANS P pressure transmitters, Z series (7MF1564-...), functional diagram

The mode of operation of the pressure transmitter is dependent on the measuring range.

##### Measuring range <1 bar (<14.5 psi)

The silicon measuring cell of the pressure transmitter has a piezo-resistive bridge to which the operating pressure is transmitted through silicone oil and a stainless steel diaphragm.

The measuring cell output voltage is fed to an amplifier and converted into an output current 4 to 20 mA. The output current is linearly proportional to the input pressure

##### Measuring range ≥1 bar (≥14.5 psi)

The thin-film measuring cell has a thin-film resistance bridge to which the operating pressure  $p$  is transmitted through a ceramic diaphragm.

The voltage output from the measuring cell is converted by an amplifier into an output current 4 to 20 mA or an output voltage of 0 to 10 V DC.

The output current and voltage are linearly proportional to the input pressure

# SITRANS P measuring instruments for pressure

## Transmitters for gauge, absolute and differential pressure

### Z series for gauge and absolute pressure

#### Technical specifications

##### SITRANS P pressure transmitters, Z series for gauge pressure, absolute pressure and level

#### Mode of operation

Measuring range < 1 bar (< 14.5 psi)	Piezo-resistive
Measuring range ≥ 1 bar (≥ 14.5 psi)	Thin-film strain gauge

#### Input

Measured variable	gauge and absolute pressure
Measured range	
• Pressure	
- Metric	0 ... 400 bar g (0 ... 5802 psi g)
- US measuring range	0 ... 6000 psi g
• Absolute pressure	
- Metric	0 ... 16 bar a (0 ... 232 psi a)
- US measuring range	0 ... 300 psi a

#### Output

Output signal	
• Current output signal	4 ... 20 mA
• Voltage output signal (only measuring range ≥ 1 bar (14.5 psi))	0 ... 10 V DC

#### Accuracy

To EN 60770-1	
Error in measurement (at 25 °C (77 °F), including conformity error, hysteresis and repeatability)	0.25 % of full-scale value – typical
Response time $T_{99}$	< 0.1 s
Long-term drift	0.25 % of full scale value/year
Influence of ambient temperature	
• Start of scale	0.25 %/10 K (0.25 %/10 K) of full-scale value
	0,7 %/10 K of fullscale value for Measuring cells < 600 mbar
• Full-scale value	0.25 %/10 K (0.25 %/10 K) of full-scale value

#### Rated operating conditions

Process temperature	-30 ... +120 °C (-22 ... +248 °F)
Ambient temperature	-25 ... +85 °C (-13 ... +185 °F)
Storage temperature	-50 ... +100 °C (-58 ... +212 °F)
Degree of protection to EN 60529	IP65

#### Design

Weight	≈ 0.25 kg (≈ 0.55 lb)
Wetted parts materials	
• Measuring cell	
- Measuring range < 1 bar (< 14.5 psi)	Stainless steel, mat. No. 14404/316L
- Measuring range ≥ 1 bar (≥ 14.5 psi)	Al <sub>2</sub> O <sub>3</sub> – 96%
• Process connection	Stainless steel, mat. No. 14404/316L
• Gasket	Viton
Process connection	See Selection and Ordering data

#### Power supply $U_H$

Terminal voltage on pressure transmitter

- For current output DC 10 ... 36 V (DC 10 ... 30 V für Ex)
- For voltage output signal (only measuring range ≥ 1 bar (14.5 psi)) 15 ... 36 V DC

#### Certificate and approvals

Classification according to pressure equipment directive (DRGL 97/23/EC)

For gases of fluid group 1 and liquids of fluid 1; complies with requirements of article 3, paragraph 3 (sound engineering practice)

Explosion protection

- Intrinsic safety "I" (only with current output) TÜV 02 ATEX 1953X
- Identification Ex II 1/2G EEx ia IIC T4
- Intrinsic safety "T.I.I.S." (only with current output) applied

Lloyds Register of Shipping

Certificate No. 05/20049 (EZ)

Germanischer Lloyd

33229-06 H

American Bureau of Shipping (ABS)

06-HG205130-PDA

Bureau Veritas (BV)

19113/AO BV

Det Norske Veritas (DNV)

A-10351

Drinking water approval (ACS)

ACS 07 ACC NY 195

Underwriters Laboratories

File E194458

#### Dimensional drawings

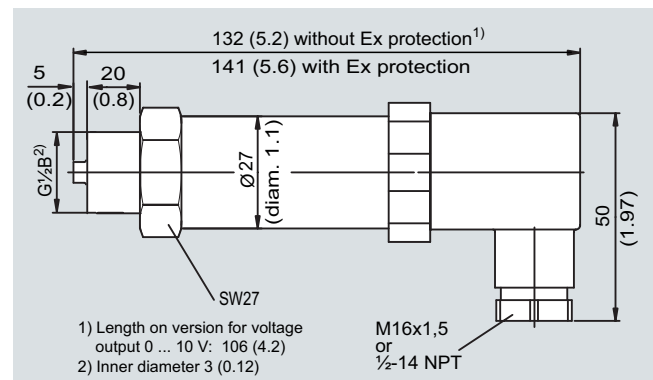

Pressure transmitter 7MF1564-... with process connection G 1/2" male, dimensions in mm (inch)

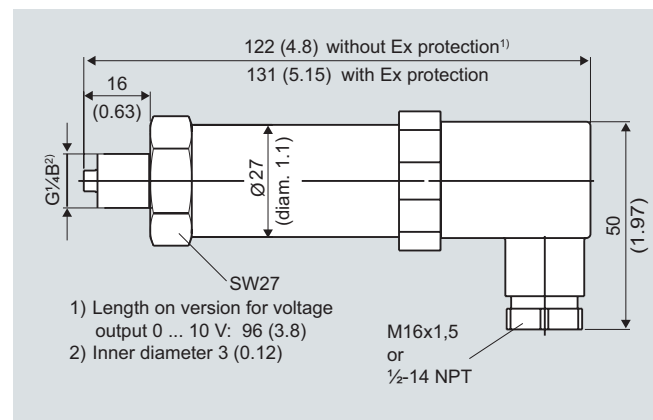

Pressure transmitter 7MF1564-... with process connection G 1/4" male, dimensions in mm (inch)

# SITRANS P measuring instruments for pressure

## Transmitters for gauge, absolute and differential pressure

### Z series for gauge and absolute pressure

2

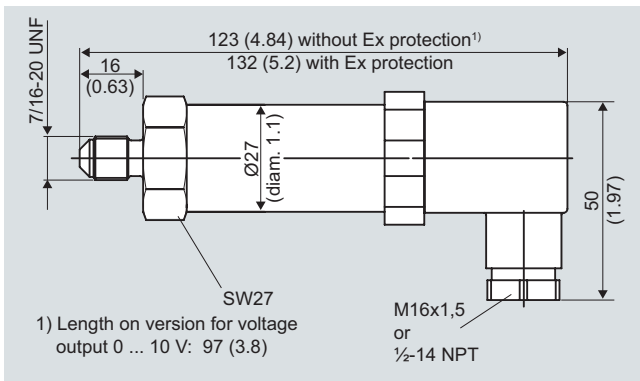

Pressure transmitter 7MF1564-... with process connection 7/16-20 UNF male, dimensions in mm (inch)

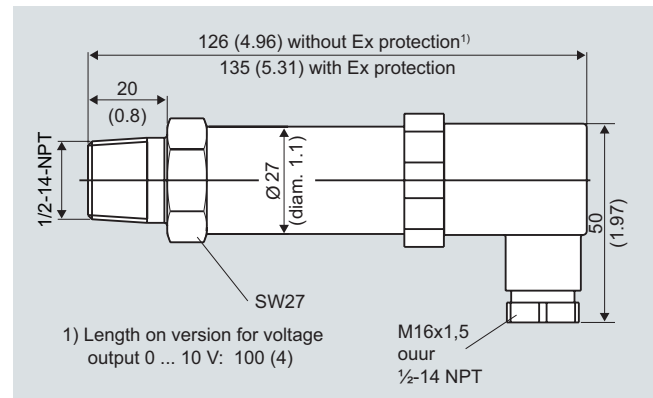

Pressure transmitter 7MF1564-... with process connection 1/2"-14 NPT male, dimensions in mm (inch)

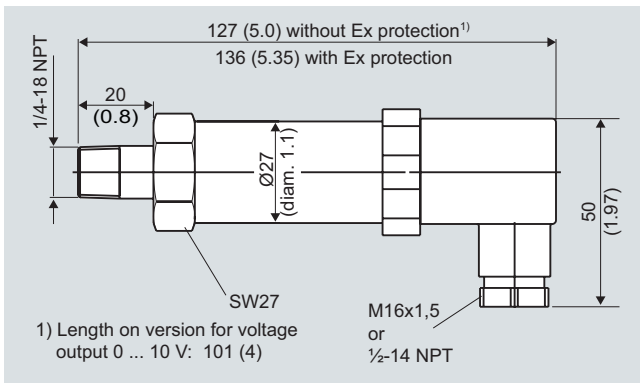

Pressure transmitter 7MF1564-... with process connection 1/4"-18 NPT male, dimensions in mm (inch)

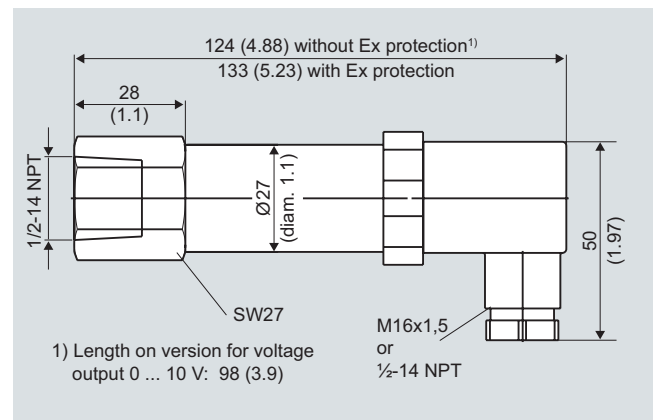

Pressure transmitter 7MF1564-... with process connection 1/2"-14 NPT female, dimensions in mm (inch)

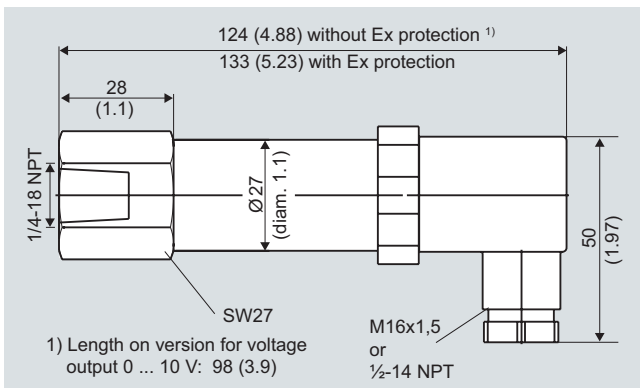

Pressure transmitter 7MF1564-... with process connection 1/4"-18 NPT female, dimensions in mm (inch)

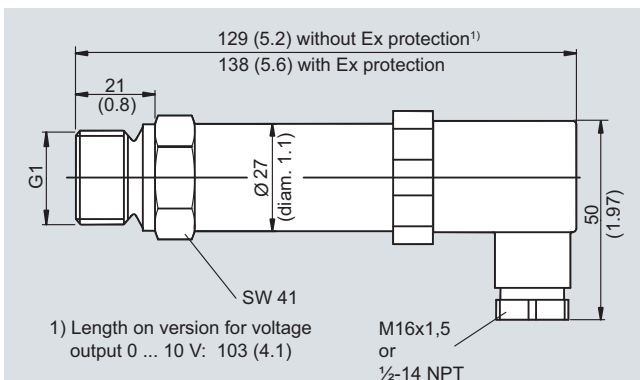

Pressure transmitter 7MF1564-... with process connection G1" male, dimensions in mm (inch)

### Schematics

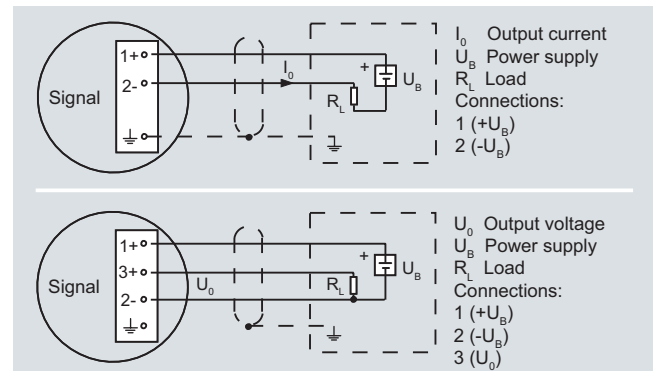

SITRANS P pressure transmitters, Z series (7MF1564-...), connection diagram, with current output (top) and voltage output (bottom)

# SITRANS P measuring instruments for pressure

## Transmitters for gauge, absolute and differential pressure

### Z series for gauge and absolute pressure

#### Selection and Ordering data

Order No.

Order code

#### SITRANS P pressure transmitters for pressure, series Z for gauge and absolute pressure

D) 7 MF 1 5 6 4 -

1

2 or 3-wire system, rising characteristic curve

Measuring range	perm. working pressure		Burst pressure			Order code
	Min.	Max.				
<b>For gauge pressure</b>						
<u>with metal measuring cell</u>						
0 ... 100 mbar g (0 ... 1.45 psi g)	-0,6 bar g (-8.7 psi g)	0,6 bar g (8.7 psi g)	1 bar g (14.5 psi g)	▶		<b>3 AA 0</b>
0 ... 160 mbar g (0 ... 2.32 psi g)	-0,6 bar g (-8.7 psi g)	0,6 bar g (8.7 psi g)	1 bar g (14.5 psi g)	▶ J)		<b>3 AB 0</b>
0 ... 250 mbar g (0 ... 3.63 psi g)	-1 bar g (-14.5 psi g)	1 bar g (14.5 psi g)	1.7 bar g (25 psi g)	▶ J)		<b>3 AC 0</b>
0 ... 400 mbar g (0 ... 5.80 psi g)	-1 bar g (-14.5 psi g)	1 bar g (14.5 psi g)	1.7 bar g (25 psi g)	▶ J)		<b>3 AD 0</b>
0 ... 600 mbar g (0 ... 8.70 psi g)	-1 bar g (-14.5 psi g)	3 bar g (43.5 psi g)	5 bar g (72 psi g)	▶ J)		<b>3 AG 0</b>
Other version for measuring range < 1 bar (< 14.5 psi g), add Order code and plain text: measuring range: ... up to ... mbar g (psi g) <sup>1)</sup>						<b>9 AC 0</b> <b>H 1 Y</b>
<u>with ceramic measuring cell</u>						
0 ... 1 bar g (0 ... 14.5 psi g)	-0,4 bar g (-5.8 psi g)	2 bar g (30 psi g)	5 bar g (72 psi g)	▶		<b>3 BA</b>
0 ... 1.6 bar g (0 ... 23.2 psi g)	-0,4 bar g (-5.8 psi g)	3,2 bar g (45 psi g)	5 bar g (72 psi g)	▶		<b>3 BB</b>
0 ... 2.5 bar g (0 ... 36.3 psi g)	-0,8 bar g (-11.6 psi g)	5 bar g (72 psi g)	12 bar g (175 psi g)	▶		<b>3 BD</b>
0 ... 4 bar g (0 ... 58.0 psi g)	-0,8 bar g (-11.6 psi g)	8 bar g (115 psi g)	12 bar g (175 psi g)	▶		<b>3 BE</b>
0 ... 6 bar g (0 ... 87.0 psi g)	-1 bar g (-14.5 psi g)	12 bar g (175 psi g)	25 bar g (360 psi g)	▶		<b>3 BG</b>
0 ... 10 bar g (0 ... 145 psi g)	-1 bar g (-14.5 psi g)	20 bar g (290 psi g)	50 bar g (725 psi g)	▶		<b>3 CA</b>
0 ... 16 bar g (0 ... 232 psi g)	-1 bar g (-14.5 psi g)	32 bar g (460 psi g)	50 bar g (725 psi g)	▶		<b>3 CB</b>
0 ... 25 bar g (0 ... 363 psi g)	-1 bar g (-14.5 psi g)	50 bar g (725 psi g)	120 bar g (1750 psi g)	▶		<b>3 CD</b>
0 ... 40 bar g (0 ... 580 psi g)	-1 bar g (-14.5 psi g)	80 bar g (1150 psi g)	120 bar g (1750 psi g)	▶		<b>3 CE</b>
0 ... 60 bar g (0 ... 870 psi g)	-1 bar g (-14.5 psi g)	120 bar g (1750 psi g)	250 bar g (3600 psi g)	▶		<b>3 CG</b>
0 ... 100 bar g (0 ... 1450 psi g)	-1 bar g (-14.5 psi g)	200 bar g (2900 psi g)	450 bar g (6525 psi g)	▶		<b>3 DA</b>
0 ... 160 bar g (0 ... 2320 psi g)	-1 bar g (-14.5 psi g)	320 bar g (4640 psi g)	450 bar g (6525 psi g)	▶		<b>3 DB</b>
0 ... 250 bar g (0 ... 3626 psi g)	-1 bar g (-14.5 psi g)	500 bar g (7250 psi g)	650 bar g (9425 psi g)	▶		<b>3 DD</b>
0 ... 400 bar g (0 ... 5802 psi g)	-1 bar g (-14.5 psi g)	600 bar g (8700 psi g)	650 bar g (9425 psi g)	▶		<b>3 DE</b>
Other version for measuring range ≥ 1 bar g (≥ 14.5 psi g), add Order code and plain text: measuring range: ... up to ... bar (psi g) <sup>1)</sup>						<b>9 AA</b> <b>H 1 Y</b>
<b>For absolute pressure</b>						
0 ... 600 mbar a (0 ... 8.7 psi a)	0 bar a (0 psi a)	3 bar a (43.5 psi a)	5 bar a (72 psi a)	▶ J)		<b>5 AG 0</b>
0 ... 1 bar a (0 ... 14.5 psi a)	0 bar a (0 psi a)	2 bar a (30 psi a)	5 bar a (72 psi a)	▶ J)		<b>5 BA</b>
0 ... 1.6 bar a (0 ... 23.2 psi a)	0 bar a (0 psi a)	3,2 bar a (45 psi a)	5 bar a (72 psi a)	▶ J)		<b>5 BB</b>
0 ... 2.5 bar a (0 ... 36.3 psi a)	0 bar a (0 psi a)	5 bar a (72 psi a)	12 bar a (175 psi a)	▶ J)		<b>5 BD</b>
0 ... 4 bar a (0 ... 58.0 psi a)	0 bar a (0 psi a)	8 bar a (115 psi a)	12 bar a (175 psi a)	▶ J)		<b>5 BE</b>
0 ... 6 bar a (0 ... 87.0 psi a)	0 bar a (0 psi a)	12 bar a (175 psi a)	25 bar a (360 psi a)	▶ J)		<b>5 BG</b>
0 ... 10 bar a (0 ... 145 psi a)	0 bar a (0 psi a)	20 bar a (290 psi a)	50 bar a (725 psi a)	▶ J)		<b>5 CA</b>
0 ... 16 bar a (0 ... 232 psi a)	0 bar a (0 psi a)	32 bar a (460 psi a)	50 bar a (725 psi a)	▶ J)		<b>5 CB</b>
Other version for measuring range < 1 bar (< 14.5 psi a), add Order code and plain text: measuring range: ... up to ... mbar a (psi a)					J)	<b>9 AB 0</b> <b>H 1 Y</b>

▶ Available ex stock

D) Subject to export regulations AL: N, ECCN: EAR99H.

J) Subject to export regulations AL: 91999, ECCN: EAR99.

<sup>1)</sup> The transmitters can also be ordered with special measuring ranges, e.g. the transmitter with the 1 bar measuring cell (14.5 psi measuring cell):  
-0.2 ... +0.8 bar g (-2.9 ... +11.6 psi g) or  
-0.4 ... +0.6 bar g (-5.8 ... +8.7 psi g) or ..., however start-of-scale value not under -0.4 bar g (-5.8 psi g), also see column "min. perm. operating pressure"

#### Please note:

- It is not possible to have a smaller span than the smallest span of the device of the entire device range.
- The value must not fall below the minimum permissible operating pressure of the special measuring range of the selected measuring cell.
- The required span of the device must lie between the smallest and the largest possible span of the entire device range.

# SITRANS P measuring instruments for pressure

## Transmitters for gauge, absolute and differential pressure

### Z series for gauge and absolute pressure

#### Selection and Ordering data

Order No.

Order code

#### SITRANS P pressure transmitters for pressure, series Z for pressure and absolute pressure

D) 7 MF 1 5 6 4 - - 1

2 or 3-wire system, rising characteristic curve

Measuring range	Perm. working pressure		Burst pressure			
	min.	max.				
<b>Measuring ranges for gauge pressure (only for US market)</b>						
(0 ... 10 psi g)	(-3 psi g)	(20 psi g)	(60 psi g)		4 BA	
(0 ... 15 psi g)	(-6 psi g)	(30 psi g)	(72 psi g)		4 BB	
(3 ... 15 psi g)	(-6 psi g)	(30 psi g)	(72 psi g)		4 BC	
(0 ... 20 psi g)	(-6 psi g)	(40 psi g)	(72 psi g)		4 BD	
(0 ... 30 psi g)	(-6 psi g)	(60 psi g)	(72 psi g)		4 BE	
(0 ... 60 psi g)	(-11.5 psi g)	(120 psi g)	(175 psi g)		4 BF	
(0 ... 100 psi g)	(-14.5 psi g)	(200 psi g)	(360 psi g)		4 BG	
(0 ... 150 psi g)	(-14.5 psi g)	(300 psi g)	(725 psi g)		4 CA	
(0 ... 200 psi g)	(-14.5 psi g)	(400 psi g)	(725 psi g)		4 CB	
(0 ... 300 psi g)	(-14.5 psi g)	(600 psi g)	(1750 psi g)		4 CD	
(0 ... 500 psi g)	(-14.5 psi g)	(1000 psi g)	(1750 psi g)		4 CE	
(0 ... 750 psi g)	(-14.5 psi g)	(1500 psi g)	(3600 psi g)		4 CF	
(0 ... 1000 psi g)	(-14.5 psi g)	(2000 psi g)	(3600 psi g)		4 CG	
(0 ... 1500 psi g)	(-14.5 psi g)	(3000 psi g)	(6525 psi g)		4 DA	
(0 ... 2000 psi g)	(-14.5 psi g)	(4000 psi g)	(6525 psi g)		4 DB	
(0 ... 3000 psi g)	(-14.5 psi g)	(6000 psi g)	(9425 psi g)		4 DD	
(0 ... 5000 psi g)	(-14.5 psi g)	(8700 psi g)	(9425 psi g)		4 DE	
(0 ... 6000 psi g)	(-14.5 psi g)	(8700 psi g)	(9425 psi g)		4 DF	
Other version, add Order code and plain text: Measuring range: ... up to ... psi g					9 BA	H 1 Y

#### Measuring ranges for absolute pressure (only for US market)

(0 ... 10 psi a)	(0 psi a)	(20 psi a)	(60 psi a)	J)	6 AG	
(0 ... 15 psi a)	(0 psi a)	(30 psi a)	(72 psi a)	J)	6 BA	
(0 ... 20 psi a)	(0 psi a)	(40 psi a)	(72 psi a)	J)	6 BB	
(0 ... 30 psi a)	(0 psi a)	(60 psi a)	(72 psi a)	J)	6 BD	
(0 ... 60 psi a)	(0 psi a)	(120 psi a)	(175 psi a)	J)	6 BE	
(0 ... 100 psi a)	(0 psi a)	(200 psi a)	(360 psi a)	J)	6 BG	
(0 ... 150 psi a)	(0 psi a)	(300 psi a)	(725 psi a)	J)	6 CA	
(0 ... 200 psi a)	(0 psi a)	(400 psi a)	(725 psi a)	J)	6 CB	
(0 ... 300 psi a)	(0 psi a)	(600 psi a)	(1725 psi a)	J)	6 CC	
Other version, add Order code and plain text: Measuring range: ... up to ... psi a				J)	9 BB	H 1 Y

#### Output signal

4 ... 20 mA; C 2-wire system; power supply 10 ... 36 V DC	▶	0
0 ... 10 V; 3-wire system; power supply 15 ... 36 V DC		10

#### Explosion protection

Without	▶	0
With explosion protection Ex II 1/2 G EEx ia IIC T4 (only for version 4 ... 20 mA; 2-wire system; power supply 10 ... 30 V DC)		1
With explosion protection "Intrinsic safety T.I.I.S." (available soon)		2

#### Electrical connection

Plug to DIN 43650, Form A, cable inlet M16 x 1.5	▶	1	
Round connector M12, IP67		2	
Plug to DIN 43650, cable inlet 1/2-14 NPT		3	
Plug to DIN 43650, cable inlet Pg11		4	
Cable gland Pg11 with 2 m PE cable, IP68		6	
Special version (specify Order code and plain text)		9	N 1 Y

▶ Available ex stock



D) Subject to export regulations AL: N, ECCN: EAR99H.

J) Subject to export regulations AL: 91999, ECCN: EAR99.

# SITRANS P measuring instruments for pressure

## Transmitters for gauge, absolute and differential pressure

### Z series for gauge and absolute pressure

Selection and Ordering data	Order No.	Order code
<b>SITRANS P pressure transmitters for pressure, series Z for pressure and absolute pressure</b> 2 or 3-wire system, rising characteristic curve	D) <b>7 MF 1 5 6 4 -</b>  <b>-</b>  <b>1</b> 	
<b>Process connection</b> G½" male to EN 837-1 (½" BSP male) (standard for metric pressure ranges mbar, bar) G½" male thread and G1/8" female thread G¼" male to EN837-1 (¼" BSP male) 7/16"-20 UNF male ¼"-18 NPT male (standard for pressure ranges psi) ¼"-18 NPT female ½"-14 NPT male ½"-14 NPT female RC ½" male to JIS B 7505 G1" male (only for measuring ranges ≥ 1 bar g (14.5 psi g)) and max. permissible working pressure 100 bar g (1450 psi g) Special version (specify Order code and plain text)	▶	A B C D E F G H K M Z    P 1 Y
<b>Sealing material between sensor and housing</b> Viton (standard) Neoprene Perbunan Special version (specify Order code and plain text)	▶	A B C Z    Q 1 Y
<b>Further designs</b> Quality inspection certificate (Factory calibration) to IEC 60770-2, add "-Z" to Order No. and Order code.		Order code <b>C11</b>
<b>Accessories</b> Quality inspection certificate (Factory calibration) to IEC 60770-2 supplied later, specify factory no. of transmitter.		Order No. D) <b>7MF1564-8CC11</b>

▶ Available ex stock

D) Subject to export regulations AL: N, ECCN: EAR99H.